

TECSUN

RADIOS AUSTRALIA

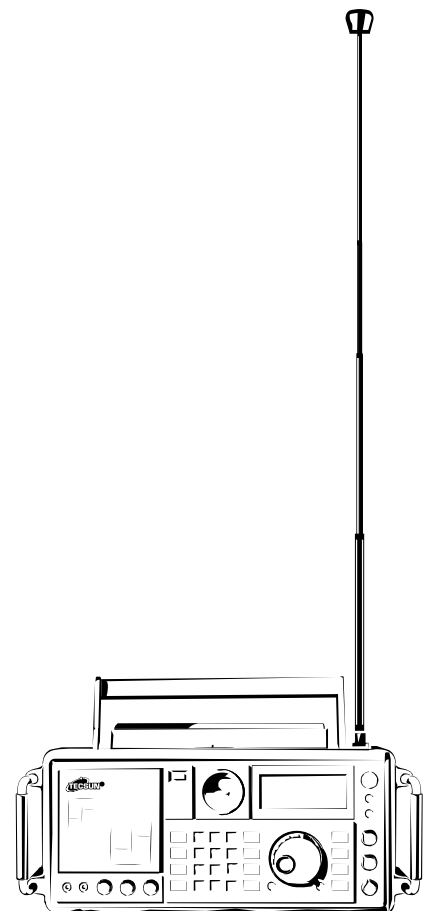

TECSUN RADIOS AUSTRALIA

24/9 Powells Road, Brookvale, NSW 2100 Australia
Email: info@tecsunradios.com.au

Ph: +61 2 9939 4377
www.tecsunradios.com.au

TECSUN
RADIO AUSTRALIA

S-2000

**FM-stereo/ LW / MW / Shortwave / Aircraft Band Radio
Receiver with SSB (Single Side Band)**

OWNER'S MANUAL

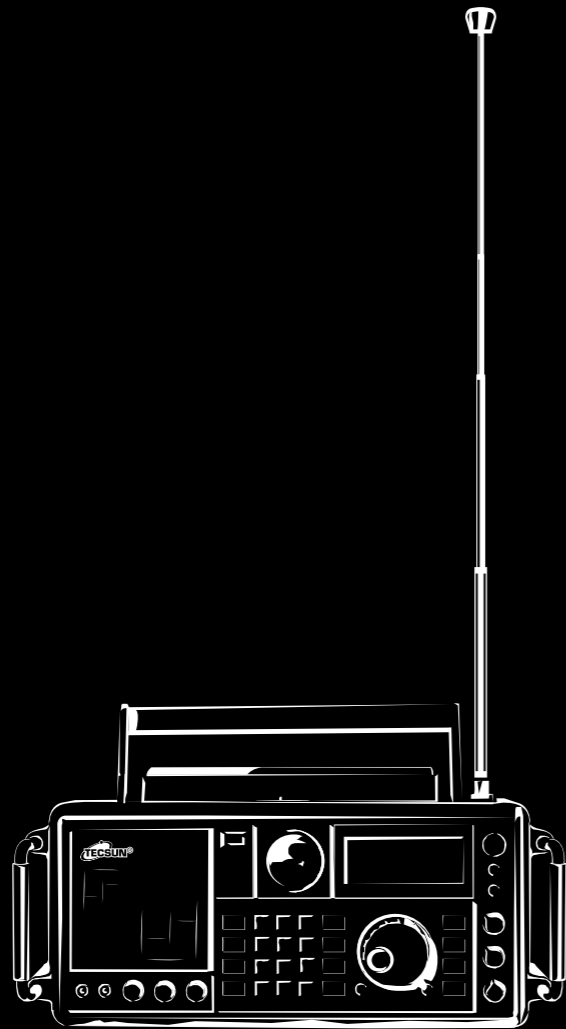

TECSUN RADIO AUSTRALIA

MADE IN CHINA

FEATURES

www.tecsunradios.com.au

Thank you for purchasing TECSUN S-2000 receiver. Its features is shown as below:

- MW 522-1620 kHz (9k Tuning Step)
520-1710 kHz (10k Tuning Step)
- LW 100-519 kHz
- SW 1711-29999 kHz
- AIR 118-137 MHz
- FM 87-108 MHz
88-108 MHz (America)
76-108 MHz (Japan)
- FM stereo via Earphones or Headphones.
- Dual Conversion for LW, MW & SW
- Single Side Band (SSB) with USB & LSB
- Auto/Manual Frequency Tuning or Station Memory Tuning or Direct Frequency Key-in Function
- Auto Tuning Storage (ATS) Function for FM / MW & LW (5s Pre-listening while Auto Tuning)
- 1000 Station Memories (100 each for FM, SW, SSB & Air Band; 50 each for MW & LW; 500 for Mixed Band)
- 24 Hrs Clock & Dual Alarm Clock Function (Alarm by either Radio or Buzzer)
- Sleep Timer Function
- Extra Long Telescopic Antenna for FM, SW, Air Band.
- 360 Degrees Rotating MW Antenna
- External or Internal FM / MW Antenna Switch
- Antenna Attenuation to Enhance Reception.
- Squelch Control for Quality FM and Air Band Listening.
- Wide / Narrow Bandwidth Selection
- RF Gain Control Knob
- 455 kHz IF Output Jack for DIY (Synchronous Detection, DSP Demodulator, DRM Converter)
- High Quality Built-in 4" Speaker with Excellent Sound Effect.
- Line in Socket (can be used as speaker for MP3)
- Line out Socket (radio broadcast can be transferred to other device).
- Power Sources: 4D Alkaline Batteries
220V AC Power(AC power cord included for Asia market)
6V DC Jack (DC adaptor included for Europe market)
- Dimensions: 372 x 183 x 153 mm (W x H x D)
- Weight: 5.95 lbs (2.7 kg)

	Page
LCD DISPLAY INDICATION	2
QUICK START.....	3
TECSUN S-2000 PRODUCT ASSEMBLY DIAGRAM	4
S-2000 QUICK START GUIDE.....	5-7
S-2000 OPERATION MANUAL	
POWER SUPPLY.....	8
LISTEN TO THE RADIO.....	9
STORING FREQUENCIES INTO MEMORY.....	10~11
LISTENING TO WHAT'S STORED.....	12
DELETE MEMORY.....	13
CLOCK SETTING.....	14
ALARM SETTING.....	14-15
SLEEP TIMER.....	16
USING THE LIGHT BUTTON.....	17
BW (BANDWIDTH) BUTTON.....	17
FM ST. (FM STEREO) BUTTON.....	17
SW METER BAND SELECTION.....	17
TUNING STEP.....	18
LOCK THE TUNING KNOB.....	18
RESET BUTTON.....	18
SSB (SINGLE SIDE BAND) TUNING.....	18
LINE OUT SOCKETS.....	19
LINE-IN SOCKET.....	19
455KHZ AM IF OUTLET.....	19
ANTENNA ATEENUATOR (ANT. ATT.) BUTTON.....	20
RF GAIN CONTROL.....	20
SQUELCH CONTROL.....	20
EXTERNAL ANTENNA SOCKETS.....	21
SYSTEM CODE SETTING.....	22
CHECK THE SYSTEM CODE SETTING.....	22
TROUBLESHOOTING.....	23
SPECIFICATIONS.....	24-25
MESSAGE ALERT STATUS.....	26-28

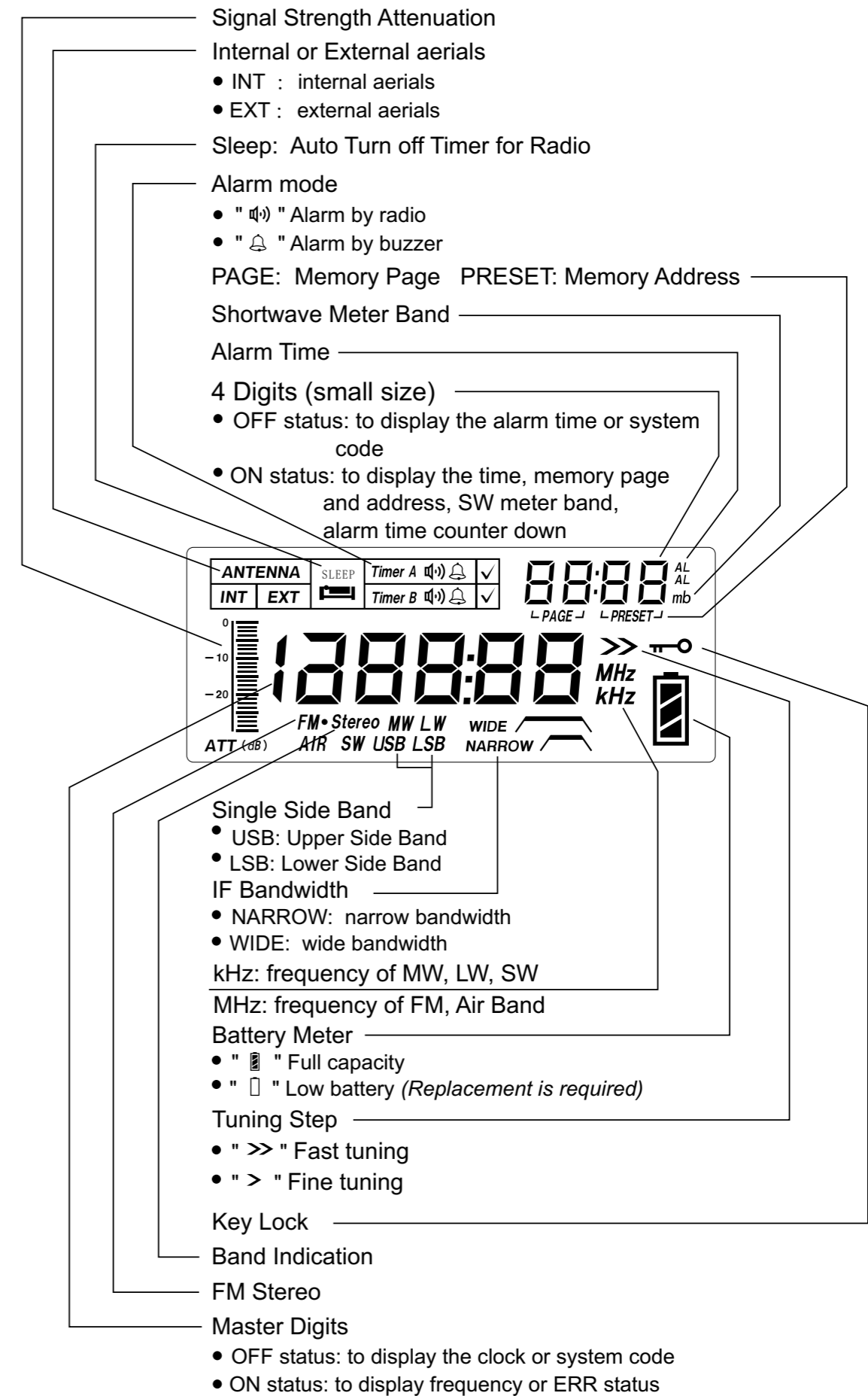

ROTATABLE MW/LW ANTENNA

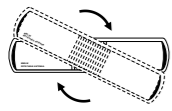

The MW/LW antenna is located at the top of the radio; rotate it for best MW/LW reception.

LIGHT/SNOOZE

LIGHT

- 3 seconds light on: short press the LIGHT button.
- Always light on: long press the LIGHT button.

SNOOZE

When the alarm is activated, press the LIGHT/SNOOZE button to deactivate the timer for 10 minutes.

TIME Clock set

CLOCK SETTING

1. Long press the TIME button, when HOUR is flashing, turn the TUNING knob to adjust the hour.
2. Shortly press the TIME button, when MINUTE is flashing then turns the TUNING knob to adjust the minute.
3. Press the TIME button to confirm.

* One can set the clock either when the radio is on or off.

TIMER A ON/OFF Alarm by radio or by buzzer

The alarm time setting is same as the clock setting. After the alarm time is set, there is one more playing timer (1 ~ 90minutes) needs to be adjusted and for active the alarm by radio. To turn off the timer, Press the TIMER A ON/OFF button over and over to deactivate the alarm when "🔊" or "🔔" are disappeared.

TIMER B ON/OFF Alarm by radio or by buzzer

※The operation method is as same as TIMER A.

EAR Earphone Socket

- Plug in earphones and headphones using a 3.5 mm (1/8 inch) stereo plug.

LINE IN Line in Socket

The LINE-IN socket is on the lower left front of the radio and allows you to route the sound from another device to the TECSUN S-2000. Use a cord with a 3.5 mm (1/8 inch) stereo plug.

BASS / TREBLE / VOLUME Adjusting knobs

BW Band width selector

Short press BW button to choose wide or narrow selectivity. This may help to reduce interference for some frequencies. Selecting WIDE, usually results of better audio fidelity, while selecting narrow that limits the audio fidelity somewhat.

SSB Single Side Band

Turn on the radio and go into Shortwave. Press the SSB button and tune in signals on USB, press the SSB button again to LSB. To return to SW band press the SSB button once more.

FM ST. FM Stereo

Press the FM ST. button when in the FM band to take the radio in or out of stereo reception mode. When using speaker to listen FM ST., please turn off FM ST. function for better sound.

DELETE

DELETE ONE MEMORY

- Turn on the radio and press the VM/VF button, causing PAGE and PRESET to appear in the display's upper right corner.
- Use the numeric keypad, the TUNING knob or the up/down tuning buttons (⏮ / ⏭) to select the memory that you want to delete. To delete the memory press the DELETE button and release after a "B" sounds, note that "DEL" starts blinking on the LCD, then press DELETE button again to confirm. Please refer to the TECSUN S-2000 manual for QUICK DELETING and DELETING A PAGE.

MEMORY

- Turn on the radio and tune to a station that you want to store into memory.
- Shortly press the MEMORY button note that PRESET will flash in the right corner of the LCD. Press the MEMORY button to confirm it (or it will automatically confirm after 3 seconds).

0 ~ 9 Numeric keys

- Frequency mode: direct key in a station frequency.
- Memory mode: direct key in a memory number to listen to what's stored.

FM

- Short press FM button: to select FM band.
- Long press FM button: to start FM ATS.

MW/LW

- Short press MW/LW button: to select MW or LW band.
- Long press on MW band: to start MW ATS.
- Long press on LW band: to start LW ATS.

SW Short-wave band

- Short press SW button: to select SW band.
- Sequentially press SW button: to select a SW meter band.

AIR Aircraft band

- Short press AIR button: to select AIR band.

STEP/FAST-SLOW/LOCK Tuning step/lock

- Short press SETP/FAST-SLOW/LOCK button: to select either FAST or SLOW tuning step.
- Long press SETP/FAST-SLOW/LOCK button: to lock the TUNING knob.

TUNING Tuning knob

One can use the TUNING knob to adjust the clock, tune to a station, select a memory address and a memory page.

Up and Down button

- Frequency mode: short press for a station tuning and long press for Auto tuning.
- Memory mode: short press for a recalling of preset and long press for auto tuning of memory.

PAGE Memory Page

- Turn on the radio and short press the PAGE button (the address page will flash in the right corner of the LCD).
- Turn the TUNING knob or use the "⏮ / ⏭" buttons to select the page that you want go to; shortly press PAGE again to confirm.

VM / VF Memory mode/ Frequency mode

VF= Variable-Frequency Oscillator mode, VM= memory mode
Short press the VM/VF button to change VM/VF mode.

RESET

Press the RESET only when the radio seems to stop functioning properly.

Telescope Antenna for FM/SW/AIR band

Pull out the telescope antenna and change its length or direction to get better reception when tuning on FM/SW/AIR band.

POWER

Short press the POWER button to turn on or turn off the radio.

SLEEP Sleep Timer

- The sleep timer enables the radio to play any length of time from 1 ~ 120 minutes and then turn off automatically.
- Press the SLEEP button to turn on the sleep timer. Notice that the number of minutes to play appears in the display. While it appears there, keep pressing on the SLEEP button to adjust the sleep timer in between 1 to 120 minutes.

ANT. ATT Antenna Attenuator

The ANT.ATT button, located on the upper right front of the radio, is used to attenuate a signal.

RF GAIN Radio Frequency Gain

The RF (radio frequency) gain controller is adjusted manually to improve the radio's rejection of interference from adjacent frequencies that may interfere, especially on Shortwave.

SQUELCH

Using the squelch control eliminates background noise.

SSB BFO Beat Frequency Oscillator

BFO stands for Beat Frequency Oscillator. This control knob is used to fine tune a sideband signal.

NOTE: it will cut off the internal AM antenna when an external AM antenna is connected.

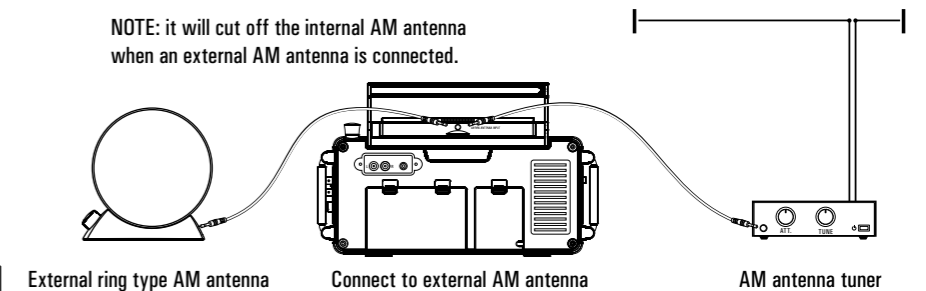

INT./EXT. antenna select switch

INT. ANT.: Use of internal telescopic antenna
EXT. ANT.: Use of external antenna

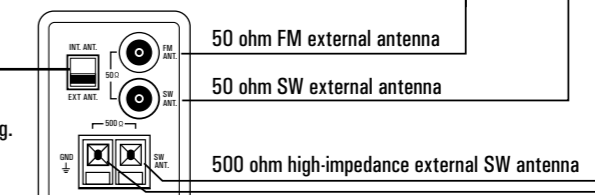

Right side

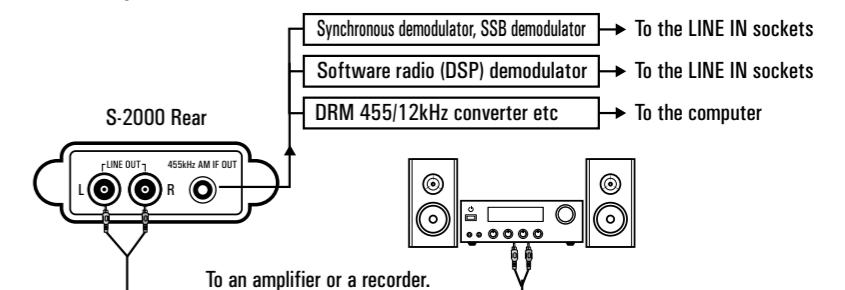

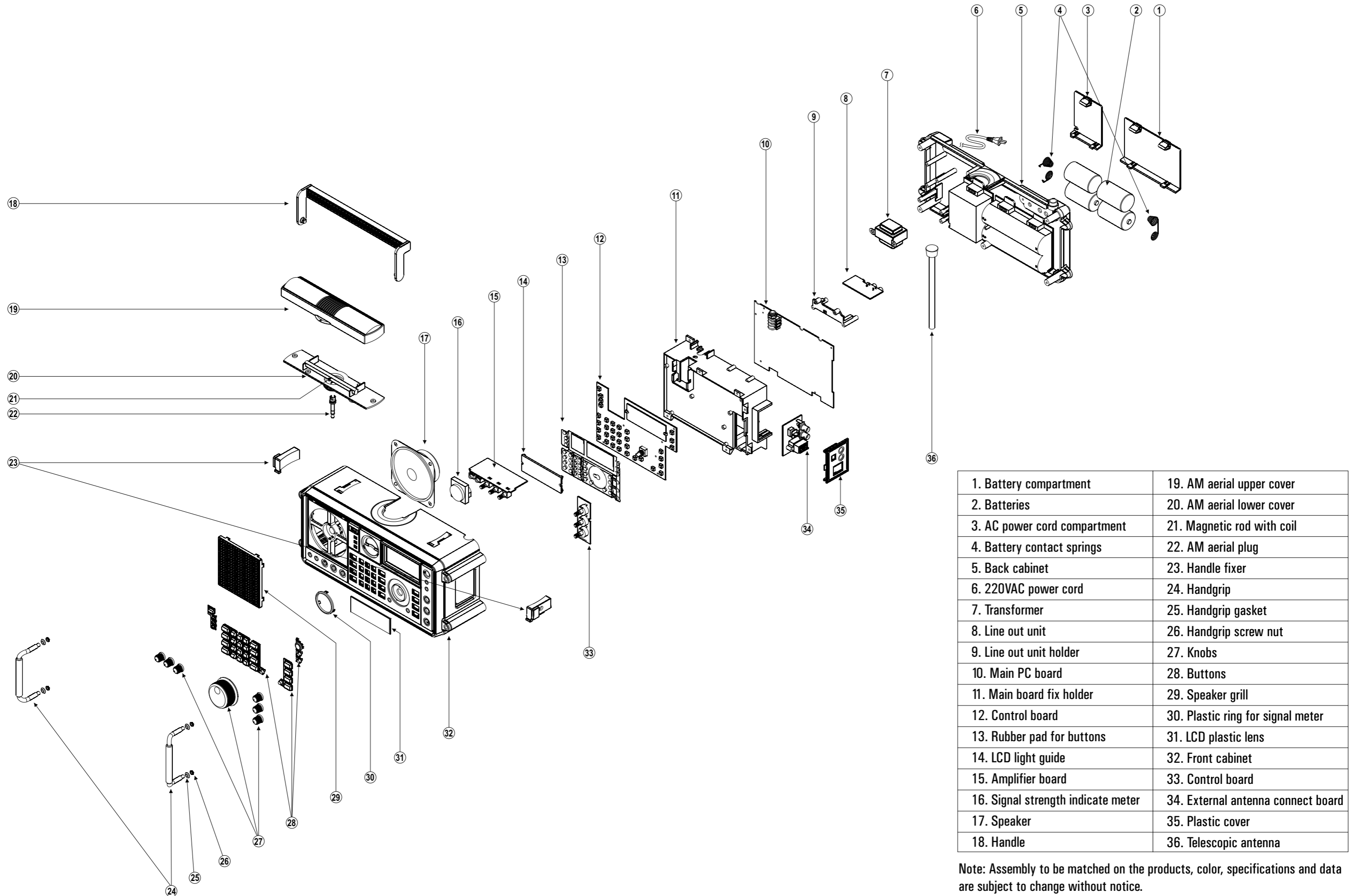

Note: Assembly to be matched on the products, color, specifications and data are subject to change without notice.

TIME SETTING



www.tecsunradios.com.au

S-2000's clock is in 24 hours format and can be set with the radio on or off. When the radio is turned off, the clock shows in mid-display. When the radio is turned on, the clock shows in the upper right corner of the LCD.

To set the clock:

1. Press the TIME button with a "B" sound until the hour is flashing.
2. While it's flashing turn the TUNING knob to set the correct number of hours; then press the TIME button again with a "BB" sound and the minutes are flashing.
3. While it's flashing turn the TUNING knob to set the correct number of minutes; then press TIME to confirm, and release it after a long "B--" sounds.

Note:

1. After setting the hour or minutes, you can simply let the flashing number time-out, without pressing the TIME button to confirm the setting.
2. You can use the  /  buttons or direct input the numbers to set the clock.

ALARM SETTING

There are two independently programmable alarm timers (TIMER A ON/OFF & TIMER B ON/OFF) to turn it on and off at the specified time.

To set for TIMER A ON/OFF:

1. Press the TIMER A ON/OFF button with a "B" sound until you see the alarm hour flashing. While it's flashing adjust the hour with the TUNING knob and press the TIMER A ON/OFF button with a "BB" sound. Notice that the alarm minutes are flashing.
2. While it's flashing adjust the alarm minutes with the TUNING knob and press the TIMER A ON/OFF button. Notice the sleep timer flashing in the box at the top of the display.
3. While it's flashing turn the TUNING knob to adjust the time that the radio is to play(1~90 minutes).
4. Press the TIMER A ON/OFF button again to confirm setting, or simply let the flashing number time-out to confirm it automatically meanwhile with a long "B--" sounds.
5. To set for TIMER B ON/OFF is the same as for TIMER A ON/OFF.



Note:

Once the alarm is on (by radio or buzzer), only the POWER, SLEEP, LIGHT/SNOOZE, and RESET buttons can be operated. Press the POWER or SLEEP buttons to turn off the alarm.

Alarm by Buzzer or Radio:

Press on TIMER A ON/OFF key to select “” in TIMER A section. Now the alarm will be on by buzzer.

Note:

In TIMER A or B section, “” means TIMER is set by radio; “” means TIMER is set by buzzer, and [] means TIMER is off.

LISTEN TO THE RADIO

www.tecsunradios.com.au

1. Press the POWER button to turn on/off the radio.
2. Select FM by pressing the FM button, MW(AM) and LW by pressing the MW/LW button (press it twice for LW), SW by pressing the SW button sequentially until you have selected the desired meter band (meter band number flashes in the upper right corner of the display) and the Aircraft band by pressing the AIR button.
3. Turn the TUNING knob to your desired radio station.
4. You can also direct key-in the frequency numbers.
5. Adjust the volume, bass and treble tuning knobs for better sound.

Note:

Be sure to fully extend the telescopic antenna when listening to SW, FM and AIR. The swivel AM antenna is located at the top of the radio; swivel it for best AM (MW/LW) reception.

ATS (AUTO TUNING STORAGE) for FM, MW / LW

To automatically store the strongest LW, MW or FM stations into Page 0.







To activate the ATS function, turn on the radio and fully extend the antenna, then long press the FM button with a "B" sound and until the frequency number is running on the display. Notice that page 0 (P0) appears in the display's upper right corner with the presets to the right increasing as the band is scanned and frequencies are stored into the memory. Once it is done, turn the TUNING knob to select those stored stations.

MW/LW ATS is same as the FM ATS.

STORING FREQUENCIES INTO MEMORY

To store a frequency into the next available memory on the page that you've selected, press the MEMORY button with a "B" sound. Note that PRESET flashes with the next available memory number. Press the MEMORY button with a long "B --" sound to automatically store it into the next available memory or when it stops flashing it's stored into the memory number that was flashing.

LISTENING TO WHAT'S STORED

1. Turn on the radio and go to the correct page by pressing PAGE and entering it with the numeric keypad.
2. Press and release the VM/VF button and notice that the PAGE and PRESET show in the display's upper right corner.
3. To go from one memory to another give a quick, short press to either the  /  tuning buttons, or use the tuning knob.
3. To auto-scan memory press one of the  /  tuning buttons for about 2 seconds and notice that PRESET flashes. the radio scans form one memory to another, staying on each memory for about 5 seconds. To stop the scan, give the  /  tuning button a quick, short press.
5. Moreover, you can also direct enter the address numbers within its page.

DELETE MEMORY

www.tecsunradios.com.au

1. Delete one memory

- Turn on the radio and press the VM/VF button, causing PAGE and PRESET to appear in the display's upper right corner.
- Use the numeric keypad, the tuning knob, or the Δ / ∇ buttons to select the memory that you want to delete.
- To delete the memory, press DELETE button with a "B" sound and notice that DEL flashes in the display. Press the DELETE button again with a long "B --" sound to confirm.

2. Delete a memory page

- Turn on the radio and select the page that you want to delete by pressing PAGE, note that PAGE flashes in the display's upper right. While it's flashing use the numeric keypad, the tuning knob or the Δ / ∇ buttons to select the page that you wish to delete.
- Press and release the VM/VF button so that PAGE and PRESET appear in the display's upper corner. If [- -] appears above PRESET in the display's upper right corner, the page is already deleted and you don't have to continue.
- Press DELETE for about 3 seconds with a "BB" sound or until DEL starts blinking on the LCD, press the DELETE button again with a long "B--" sound to confirm.

AUTO SCAN STATION AND PRESET MEMORY

AUTO SCAN STATION

To auto scan station, turn on the radio and select your desired band. Long press one of the Δ / ∇ buttons with a "B" sound to activate the Auto Scan function. In Auto Scan the radio scans from one station to the next, stays on the new station for 5 seconds and then moves on. You can press any button with a "BB" sound to stop the Auto Scan function.

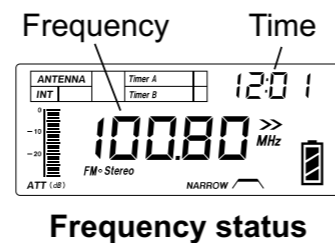

AUTO SCAN MEMORY

Turn on the radio and press VM/VF with a "BB" sound, then press one of the Δ / ∇ buttons for about 2 seconds with a "B" sound and notice that PRESET flashes. The radio scans from one memory to another, staying on each memory for about 5 seconds. You can press any button with a "BB" sound to stop Auto Scan and listen to your favorite broadcast.

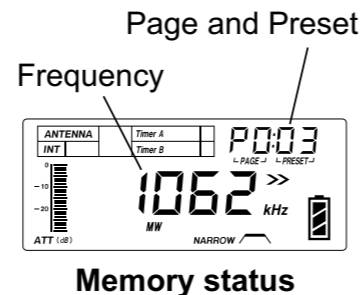

POWER SUPPLY

www.tecsunradios.com.au

USING BATTERIES

- Open the battery compartment cover and insert 4 x UM 1 (D size) batteries according to the polarity diagram imprinted on the battery compartment floor.
- The S-2000 has a battery power indicator in the LCD. Fresh batteries will show a full power level of 3 bars. If the indicator shows one bar or the sound becomes weak and distorted, replace the batteries.
- The radio will turn off automatically if the batteries become too weak.
- Check the batteries periodically for leakage. As a precaution, remove the batteries to prevent possible leakage if it is to be stored for long periods without use.

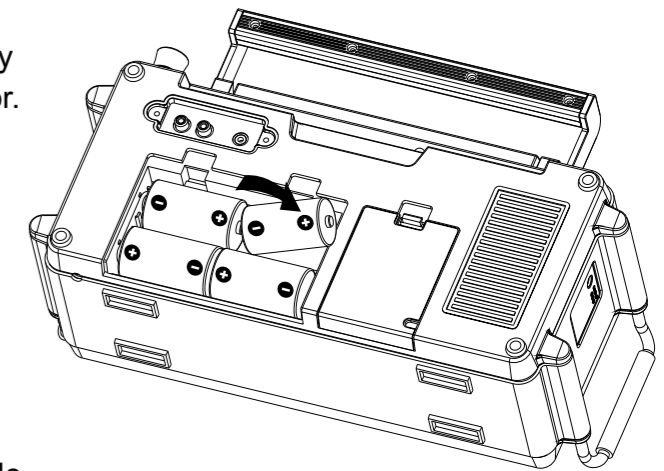

Batteries insertion

POWER BY AC (For Asia market)

Open the AC power cord compartment, pull out the 220V AC cord and plug it into the wall outlet.

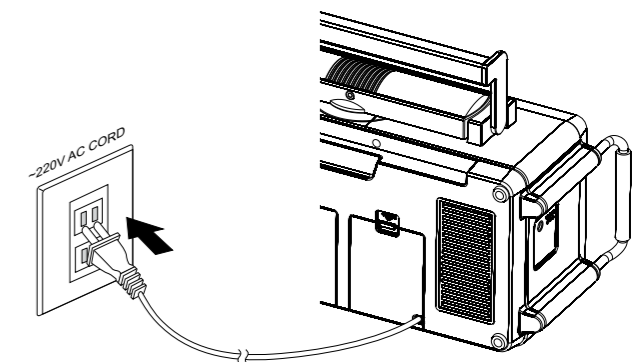

USING DC ADAPTER (For Europe market)

Connect the adaptor, first to the wall outlet, then to the S-2000 (Assure the unit is turned off).

NOTE:

- Adapter: DC 6V/350mA, negative polarity $\oplus \ominus$
- If there's a power failure with the AC or the AC adaptor and batteries installed, the batteries will take over and supply power to the radio.

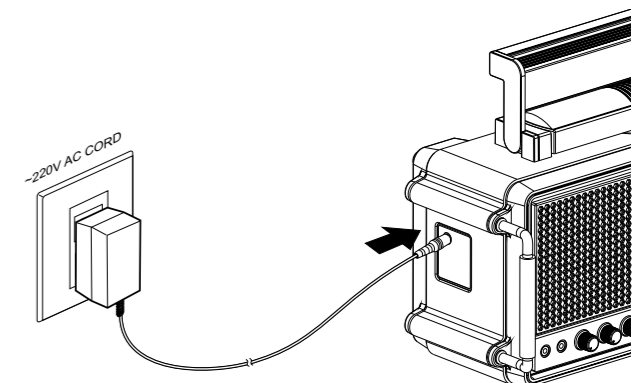

Press the POWER button to turn on the radio, select your band by pressing the FM, MW/LW, SW, or AIR button.

There are three methods to tune in the radio station:

USING TUNING KNOB

The TUNING knob can be used to tune stations. Select FAST or SLOW tuning with the STEP button, under the tuning knob. FAST/SLOW tuning is shown in the chart below for each band. If you want to LOCK the tuning knob press the STEP button for about 3 seconds. Do a quick, short press to unlock it.

	FM	MW	LW	SW	AIR	SSB
FAST >>	0.1MHz	9/10kHz	9kHz	5kHz	0.025MHz	5kHz
SLOW >	0.01MHz	1kHz	1kHz	1kHz	0.001MHz	1kHz/BFO

Note: Be sure to fully extend the telescopic antenna when listening to SW, FM and AIR. The swivel AM (MW/LW) antenna is located at the top of the radio; swivel it for best AM (MW/LW) reception.

USING ▲ / ▼ BUTTON TUNING

Quick, short, sequential presses of the ▲ / ▼ buttons enables tuning up or down frequency. A longer press engages Auto Tuning. During Auto tuning, the radio scans from one station to the next, stays on the new station for 5 seconds and then moves on.

To stop Auto Tuning, press any key.

DIRECT FREQUENCY ENTRY

Use this method when the desired frequency of a radio station is known. MW and SW frequencies are entered in kilohertz (kHz), e.g. 567 kHz or 15100 kHz; FM and AIR frequencies are entered in megahertz (MHz), e.g. 100.8 MHz, ignoring the decimal point. Use the numeric keypad to enter the frequency directly.

Note:

- No need to enter decimal point for FM and Air Band when input the frequency numbers. For example, FM 89.0 MHz, Just ENTER 8 9 0 or FM 104.0 MHz, ENTER 1 0 4 0. (or press 8 9 ENTER, and 1 0 4 ENTER).
- For SW band in between 1711~2999kHz, simply input the frequency number then press ENTER to confirm. For example, SW 2650kHz, just input 2650 ENTER . If SW frequency in between 3000~29999kHz, just input the numbers directly (no need to press the ENTER button to confirm).
- For any mis-typed number, simply press DELETE button to cancel it.
- Err will appear on the display, when entering any outbound frequency.

There are 1000 memories with S-2000. 500 memories fixed within P0 page, and 500 memories set for other storage space. Please see bellows:

Band	Store	Storage space in P0 page		Other storage space 500 MEMORIES
		P0 (page)	ATS	
FM		100	✓	10 pages each with 50 memories
SW		100	✗	20 pages each with 25 memories
SSB		100	✗	25 pages each with 20 memories
AIR		100	✗	50 pages each with 10 memories
MW		50	✓	(See the system setting chart to change above pages)
LW		50	✓	

Memory PAGE 0, noted as 'P0', consists of 500 memories, 100 assigned for FM, SW, SSB and Air Band; 50 memories each assigned for MW and LW.

Memory PAGE 1 -10, noted as 'P1', 'P2', etc., consists of 50 memories per page, 500 memories total. You can also change the pages within the system setting.

1) ATS (AUTO TUNING STORAGE)

One can automatically store the strongest LW, MW or FM stations into its own Page 0. Turn on the radio and select the band that you want ATS to take place in, either MW/LW or FM. Press the MW/LW or FM and release after a "B" sounds. Notice that page 0 (P0) appears in the display's upper right corner with the presets to the right increasing as the band is scanned and frequencies are stored into the memory. It will stop when ATS finishes with a long "B --" sound and listen to the radio station stored in P0:01.

Then you can use the TUNING knob or the ▲ / ▼ buttons to select and listen to what's stored.

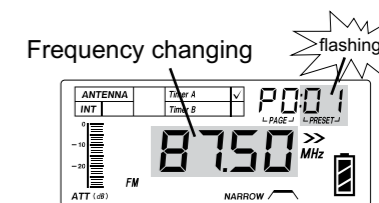

Note:

Some noise-stations and blank-stations may also store into page 0 during ATS process cause by the interference. Please try the ATS again by lower down the telescopic antenna for FM stations or rotate the MW/LW antenna for MW & LW stations or press ANT. ATT. button to lower the ATT. (dB) level.

If the interference is very bad for ATS, please change to manual storage.

2) MANUAL STORAGE

To manually store a frequency into a memory, turn on the radio and tune to a station that you want to store into memory, then long press the MEMORY button / short press it twice / or short press it and wait for 3 seconds until a long B sound to confirm it.

3) AUTO SCAN (QUICK) STORAGE

- Press and release the VM/VF button with a "B" sound and notice the time shows in the upper right corner of display.
- Press Δ / ∇ buttons for about 2 seconds, a "B" will sound, and the radio scans from one station to another, staying on each station for about 5 seconds. Quick press the MEMORY button with a long "B --" sound to store your desired station before the frequency running to the next available station. To stop the scan, press any buttons except the MEMORY button.

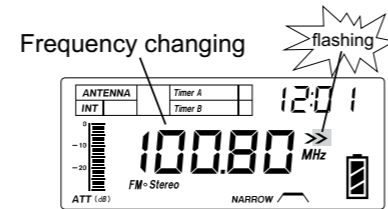

Note: This function is not available for Air Band and SW SSB.

4) STORE A STATION INTO ANOTHER PAGE

To store a frequency into a memory in another page, first choose the page, then the memory location and then store the frequency.

- Turn on the radio and tune to your desired station.

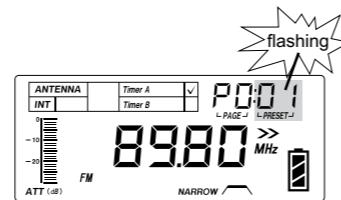

- Shortly press the MEMORY button with a "B" sound, note that PRESET will flash in the right corner of the LCD.

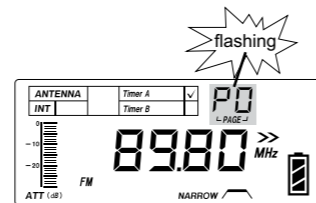

- Shortly press the PAGE button with another "B" sound and PAGE will flash in the right corner of the LCD.

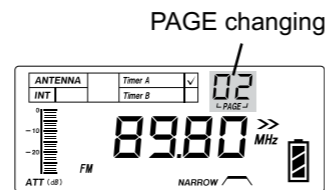

- While the PAGE is flashing, use the Δ / ∇ buttons or turn the TUNING knob or key in the number of a page to select the page that you want to store into.

- Press the [MEMORY] button to confirm it with a long "B --" sound (or it will automatically confirm after 3 seconds with a long "B --" sound.)

- Turn on the radio and go to the correct page by pressing PAGE and entering it with the numeric keypad or using the TUNING knob or Δ / ∇ button.

- Press and release the VM/VF button with a "BB" sound and notice that the PAGE and PRESET show in the display's upper right corner.

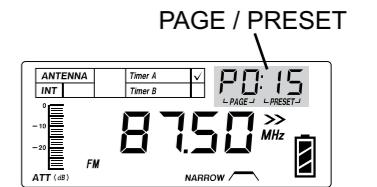

- To go from one memory to another give a quick, short press to either the Δ / ∇ button, or rotate the TUNING knob.

- To auto-scan memory press one of the Δ / ∇ buttons for about 2 seconds with a "B" sound and notice that \leftarrow PRESET \rightarrow flashes in the upper right corner. The radio scans from one memory to another, staying on each memory for about 5 seconds. To stop the scan, short press any button with a "B" sound.

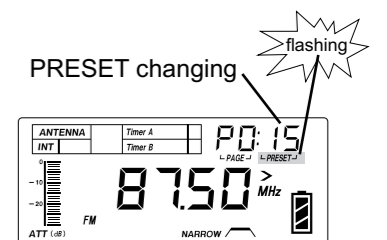

To go to a memory you already know, direct key in two digits of the memory location.

NOTE:

1. There is no auto-scan memory function in AIR and SW SSB band.
2. If the page is 50, only key in 1-9 of the memory location.
3. When " - - - - " appeared in the display with a "BB" sound after you key in a number of the memory, means there is nothing stored.
4. When " E r r " appeared with a long "B" sound, means the number keying in excess.

New added function – Sorting all stored station memories automatically

Utilize the [AIR] button to automatically sort stored stations [\equiv]. This function is able to:

1. Clearing up duplicate stations. Especially useful after storing stations manually, as you might sometimes store a station more than once.
2. Auto- sorting the sequence of stored stations.
 - In page P0, select your desired band to find all stored stations in sequence of frequency (from small to large).
 - In page 01-XX (10/20/25/50 pages), all stored stations are placed in sequence of frequency (from small to large), and in sequence of FM, SW, MW, Air band, LW.

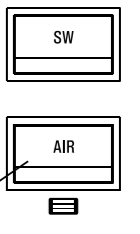

AIR Auto Sorting memory

How to operate the Auto Sorting memory function:

In radio-off mode, to auto sort the memory from page to page, press and hold the [\equiv] button for 2 seconds until the memory page number in the upper right corner starts running.

DELETE PRESET MEMORY

- Turn on the radio and press the VM/VF button with a "BB" sound, causing PAGE and PRESET to appear in the display's upper right corner.
- Use the numeric keypad, the TUNING knob or the up/down buttons (Δ / ∇) to select the memory that you want to delete.
- To delete the memory press the DELETE button for about 1 second and release after a "B" sound, note that the PRESET and **DEL** are blinking on the display. Then quickly short press the DELETE button again to confirm with a long "B" sounds. If you do not press DELETE to confirm in 3 seconds while the PRESET and **DEL** are blinking, the deleting process will be quitted.

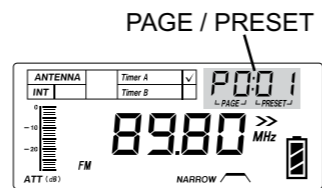

DELETE A MEMORY PAGE

- Turn on the radio and select the page that you want to delete by pressing PAGE with a "B" sound, note that page flashes in the display's upper right. While it's flashing use the numeric keypad, the TUNING knob or the up or down buttons (Δ / ∇) to select the page that you wish to delete.
- Press and release the VM/VF button with a "BB" sound, so that PAGE and PRESET appear in the display's upper right corner. If " - - " appears above PRESET in the display's upper right corner, the page is already deleted and you don't have to continue.

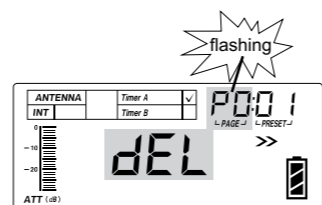

- Press DELETE for about 3 seconds with a "BB" sound or until PAGE is blinking, then press DELETE again with a long "B --" sound. If you do not press DELETE to confirm in 3 seconds while the PAGE and **DEL** are blinking, it will exist the process, memory will not be deleted.

QUICK DELETE WITH AUTO SCAN

- Press and release the VM/VF button with a "BB" sound and notice the PAGE and PRESET appear in the upper right corner of display.
- To auto scan memory, press one of the Δ / ∇ buttons for about 2 seconds with a "B" sound. The radio scans from one memory to another, staying on each memory for about 5 seconds. To delete the memory give the DELETE button a quick, short press (shows on the display) and a long "B--" sounds.

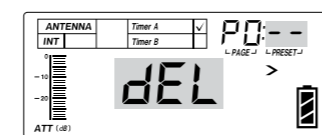

QUICK DELETE

The TECSUN S-2000's clock is in 24-hour format and can be set with the radio on or off. When the radio is turned off, the clock shows in mid-display. When the radio is turned on, the clock shows in the upper right corner of the LCD display.

To set the clock:

Press the TIME button for about a second with a "B" sound until you see the hour flashing.

1. While it's flashing turn the TUNING knob to set it to the correct hour, then press TIME again with a "BB" sound to confirm and note that the minutes are flashing. Turn the TUNING knob to set it to the correct minutes; then press TIME with a long "B" sound to confirm.
2. Another way to set the clock is by direct enter hour and minutes with numbers. (For example, 14:50pm, just enter 1 4 5 0)

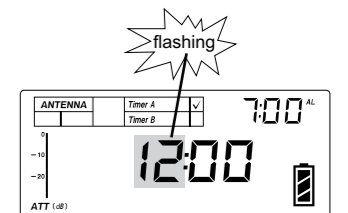

The clock shows in the center of the LCD when the radio is off.

Note:

1. After setting the hour or minutes you can simply let the flashing number time-out, without pressing the TIME button to confirm the setting.
2. You can also use the Δ / ∇ buttons to adjust the hour and minute instead of using the TUNING knob.

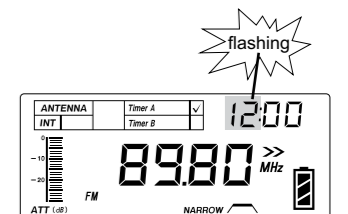

The clock shows in the upper right corner of the LCD when the radio is on.

ALARM SETTING

There are two independently programmable alarm timers (TIMER A or TIMER B ON/OFF) to turn it on and off at a specified time.

To set an alarm:

1. Turn off the radio and press the TIMER A or B ON/OFF button with a "B" sound or until you see the alarm hour flashing in the upper right corner of the display. While it's flashing adjust the hour with the TUNING knob and press the TIMER A or B ON/OFF button with a "BB" sound and notice that the alarm minutes are flashing.
2. While it's flashing, adjust the alarm minutes with the TUNING knob and press the TIMER A or B ON/OFF button with another "BB" sound and notice the sleep timer flashing in the box at the top of the display.

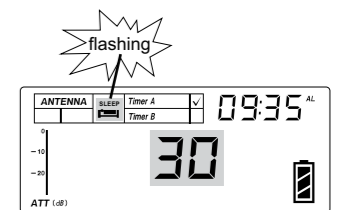
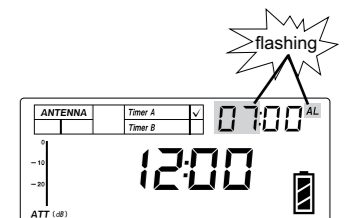

- While it's flashing, adjust the time that the radio is to play (1~90 minutes) with the TUNING knob and press the TIMER A or B ON/OFF button with a long "B--" sound or simply let the flashing number time-out to confirm it automatically.

After the alarm setting, it will auto start the alarm by radio note that "🔊" appears on the display.

To activate the alarm by radio

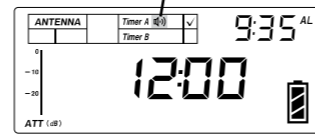

Note:

You can also use the up or down (▲ / ▼) buttons to adjust the hour and minute or direct key in hour and minute instead of the TUNING knob.

SELECT ALARM BY RADIO OR BY BUZZER

The TECSUN S-2000 has two alarm modes, alarm by radio or by buzzer.

- To activate the alarm by radio, press TIMER A or B ON/OFF once with a "B" sound and notice that the "🔊" symbol shows up in the TIMER A or B display section.
- To activate the alarm by buzzer, press again the TIMER A or B ON/OFF with a "BB" sound and notice that the "🔔" symbol appears in the TIMER A or B display section.
- Press again the TIMER A or B ON/OFF button with a long "B--" sound and notice nothing appears in the TIMER A or B display section to turn off the alarm.

To activate the alarm by radio

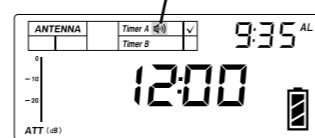

To activate the alarm by buzzer

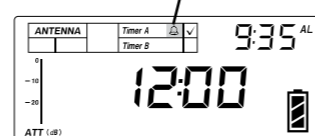

Note:

- Once the alarm is activated, no matter whether the radio is on or off, the alarm will force to listen to the station that stored in TIMER A or TIMER B, or to make a sequential sound by the buzzer, and turn off the radio in the time presetting in TIMER A or TIMER B.
- In "Timer A" or "Timer B" section:
 - "🔊" Means timer is set by radio
 - "🔔" Means timer is set by buzzer.
 - " " Means Timer is off.

TO TURN OFF THE ALARM

Once the alarm is on by radio or buzzer, only the POWER, SLEEP, LIGHT/SNOOZE, and RESET buttons can be operated. Press the POWER or SLEEP buttons to turn off the alarm.

STORING A STATION TO TIMER A OR TIMER B

- Turn on the radio and tune to a station that you want to store into TIMER A or B.
- Long press TIMER A or B ON/OFF button with a "B" sound, note that "🔊" will flash in the top of the display and then stays in section TIMER A or B.

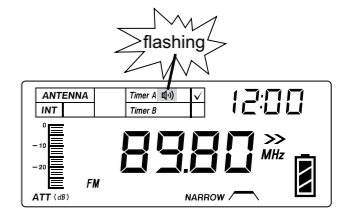

Note:

If there is no station stored into TIMER A or TIMER B or the station being stored is out, noises will be heard when the alarm is activated by radio.

SNOOZE

When the alarm is activated, press the SNOOZE button to temporarily deactivate the timer for 10 minutes, notice that "🔊" or "🔔" is blinking on the display before the alarm is activated again. You allow to use 3 times of the SNOOZE function within the alarm period, after that you can turn off the alarm by press it again and "🔊" or "🔔" stays.

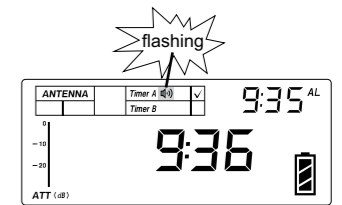

"🔊" or "🔔" is blinking on the display when snooze is on.

SLEEP TIMER

The sleep timer enables the TECSUN S-2000 to play any length of play time from 1-120 minutes and then turn off automatically.

To turn on the sleep timer, press the SLEEP button under the POWER button. Notice that the number of minutes to play appears in the display, then you can either rotate the TUNING knob or press ▲ / ▼ buttons or keep pressing the SLEEP button to adjust your desired sleep timer. Press again the SLEEP button or just leave it for about 3 seconds with a long "B --" sound to confirm your setting.

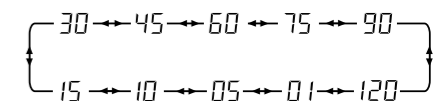

A quick press of the LIGHT button which gives about 3 seconds of illumination to the SIGNAL strength indicator and the display. A long press lights these for as long as the radio is turned on, so be careful if you're operating on batteries, because it will make them drain faster. If your AC adapter is connected, it's fine to keep the light on while the radio plays. To turn off it by short pressing the LIGHT button again.

BW (BANDWIDTH) BUTTON

Use the BANDWIDTH button to choose wide or narrow selectivity, which is shown in the lower right corner of the display as WIDE or NARROW. This may help reduce interference on some frequencies. Using WIDE usually results in better audio fidelity, while using narrow limits the audio fidelity somewhat. You can use it in FM, MW, LW, SW and SW SSB band.

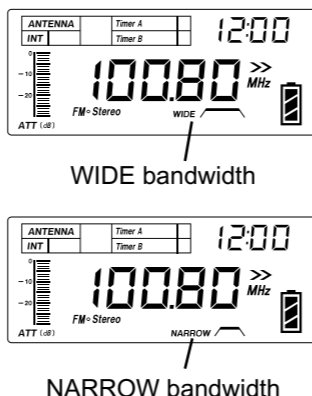

FM ST. (FM STEREO) BUTTON

Press the FM ST. button when in the FM band to take the radio in or out of stereo reception mode. When it's in stereo mode, STEREO appears under the left side of the frequency in the display, next to FM. As long as you are not using headphones or earphones, it can be left in mono mode.



SW METER BAND SELECTION

There are three ways to select SW meter band:

1. A sequence of short press of SW button, a digit of meter band with [mb] flashes on the top right corner of the display and the lowest frequency of the meter band shows in the center of the display.
2. Short press the SW button, notice that the meter band flashes on the top right corner of the display and then use the / buttons to select your desired meter.
3. Short press the SW button, notice that the meter band flashes on the top right corner of the display and then directly input the number of meter band, press again the SW button to confirm. For example, when it is in SW band, key in number 19, it goes to 19 meter band note that 19 mb is on the top right corner of the display and 15000 kHz shows in the center.

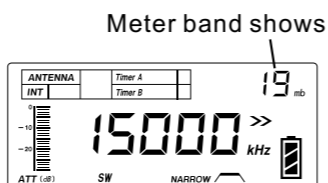

Note:

It goes to the lowest frequency of each meter band after your selection.

TUNING STEP

When you use the TUNING knob and the ▲ / ▼ buttons to tune in stations you can select FAST/SLOW tuning with the STEP button under the tuning knob. Short press the STEP button with a "B" sound, the tuning step goes SLOW " > "; short press the STEP button again with a "BB" sound, the tuning step goes FAST " >> ".

FAST/SLOW tuning is shown in the chart below for each band.

STEP	>> (FAST)		> (SLOW)	
	TUNING	▲ ▼	TUNING	▲ ▼
FM	0.1 MHz	1MHz	0.01 MHz	0.1MHz
MW	9 / 10kHz	100kHz	1kHz	9 / 10kHz
LW	9 kHz	100kHz	1 kHz	9kHz
SW	5 kHz	100kHz	1 kHz	5kHz
AIR	0.025MHz	0.1MHz	0.001MHz	0.025MHz

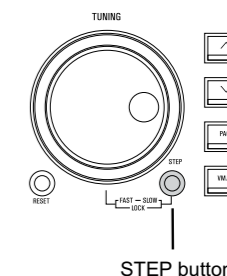

LOCK THE TUNING KNOB

If you want to LOCK the TUNING knob, press the STEP button for about 3 seconds with a long "B-" sound, note that " " shows on the display followed " > " or " >> ". Press again the STEP button with a "B" sound to unlock it and notice that " " disappears.

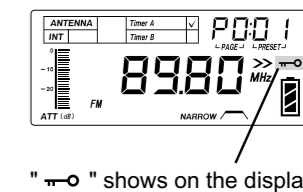

RESET BUTTON

The reset button is located in the left under the TUNING knob. Press it only when the radio seems to stop functioning properly to reboot the unit.

SSB (SINGLE SIDE BAND) TUNING

SSB enables listening to shortwave two way communications using the single sideband mode such as amateur radio, Morse code, Weather-fax transmissions and other signals often referred to as 'utility' signals.

To use the SSB control, turn on the TECSUN S-2000 and go into Short-wave. Press the SSB button with a "B" sound and notice that USB appears in the display, to the right of SW. Press the SSB button again with a "BB" sound and notice that LSB appears to the right of SW. Press the SSB button with a long "B-" sound, it goes to AM mode and USB or LSB disappears. USB is the abbreviation for Upper Sideband; LSB is the abbreviation for Lower Sideband. You can now direct key in the SSB frequency you know to tune in signals. Also notice that on the lower right front of the radio is a control knob labeled SSB BFO. BFO stands for Beat Frequency Oscillator. This control knob is used to fine tune a sideband signal frequency.

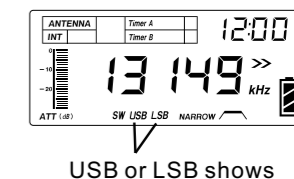

LINE OUT SOCKETS

www.tecsunradios.com.au

On the back of the radio are the left and right sockets labeled LINE OUT. You can use a connector with 3.5mm plug to transfer the audio sound to another device.

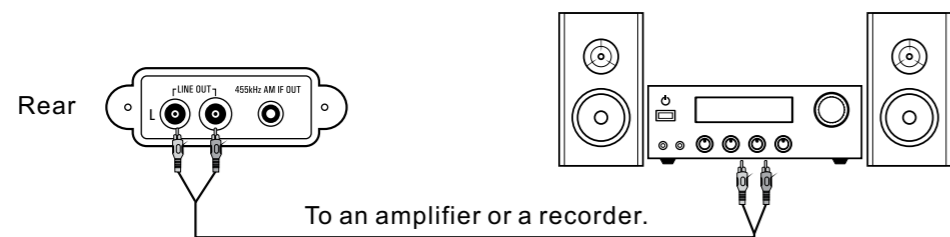

Note: The line-out output sound level is not controlled by the radio's VOLUME knob.

LINE-IN SOCKET

The LINE-IN socket is on the lower left front of the radio and allows you to route the sound from another device to the TECSUN S-2000. Use a cord with a 3.5 mm (1/8 inch) stereo plug.

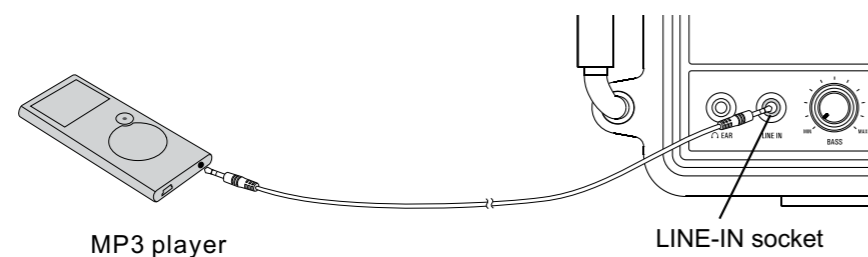

455kHz AM IF OUTLET

There is a 455 kHz AM IF outlet on the back of the radio next to the LINE OUT sockets. It is used for radio amateurs to connect some devices by DIY (Do It Yourself), ie, synchronous demodulator, SSB demodulator, software radio (DSP) demodulator, DRM 455/12kHz converter etc.

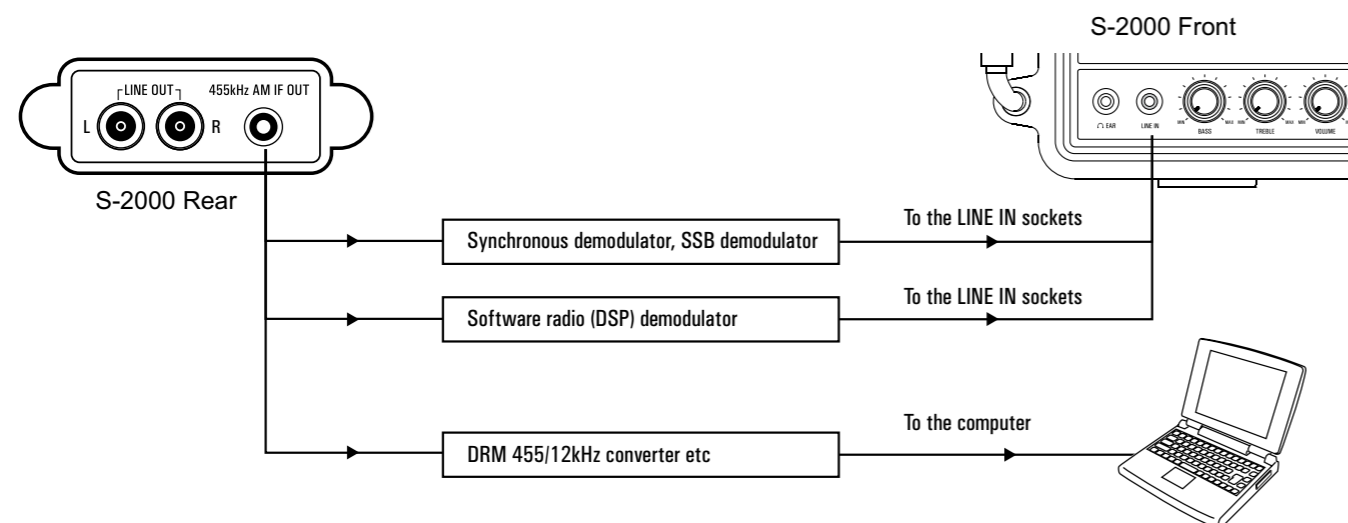

ANTENNA ATEENUATOR (ANT. ATT.) BUTTON www.tecsunradios.com.au

The ANT.ATT. button, located on the upper right front of the radio, is used to attenuate a signal. Tune into a station, then press the ANT.ATT. button and notice that the signal strength indicator, located on the left side of the display, changes at three levels. The maximum level is the highest gain and the lowest level is minimum gain. Use the lowest level (-20dB) if the signal is extremely strong and local. Use the intermediate level (-10dB) for average signals and use the highest level (0dB) for weak signals.

A message alert tone helps you to know which level you select. Sequentially short press the ANT.ATT. button, a "B" sound signifies it is lowest level; a "BB" sound signifies it is intermediate level; a long "B--" sound signifies it is the maximum level.

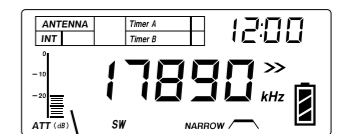

Antenna Attenuation Indication

RF GAIN CONTROL

On the right front of the radio is the RF Gain control knob. You can leave it fully counterclockwise in the AUTO position, where it will function automatically, or you can turn it clockwise and use it manually to control the RF (radio frequency) gain. Using it manually may improve the radio's rejection of interference from adjacent frequencies that may interfere, especially on Shortwave. This function does not work in FM.

SQUELCH CONTROL

Using the Squelch control eliminates background noise. This control is used mainly in the FM and the aircraft band. This control is on the lower right front of the radio. To engage it, turn it on by turning the knob clockwise. Turn it off by clicking the knob fully counterclockwise.

The external antenna sockets are used to connect the TECSUN S-2000 to advanced performance antennas.

FOR MW/LW

On the rotated AM antenna, at the top of radio, is a socket for 50 or 75 Ohm plug-in AM antenna. A loop antenna or an antenna tuner can be connected to the radio to improve the reception of MW/LW.

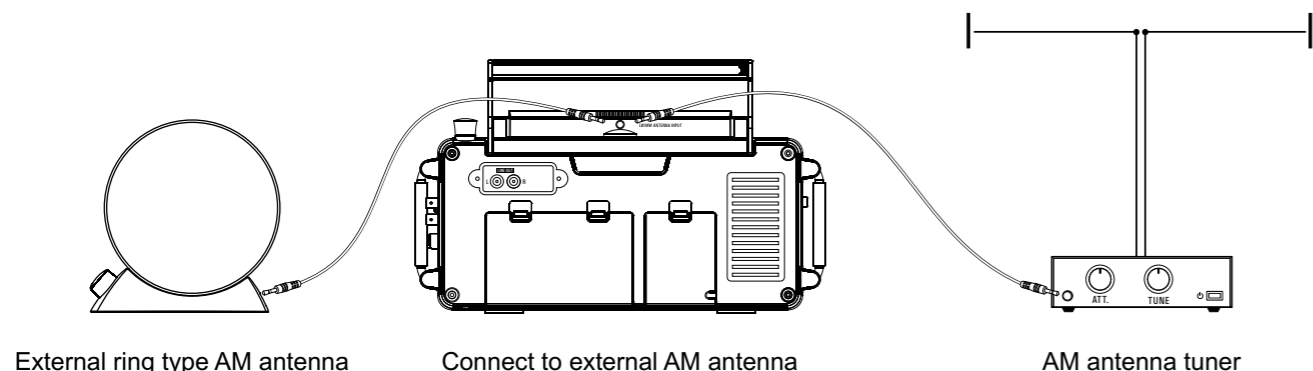

NOTE: it will cut off the internal AM antenna when an external AM antenna is connected.

FOR FM/SW

On the right side of the radio are the 50 Ohm BNC sockets for FM and Shortwave. 50 or 75 Ohm coaxial cable can be used to feed the properly designed antenna.

There is also a black and red socket, labeled 500 Ohms, designed to work with a high impedance Shortwave Antenna, 500 Ohms, such as a long wire antenna. Plug a long piece of wire, 10 to 35 meters or 30 to 100 feet, into the red socket and position it above ground, running in as much a straight line as possible, not touching any other metal objects. If you do this indoors, position the wire as close to windows as possible. Plug a 10 to 20 meter or 30 to 60 feet wire into the black socket and let it run on the floor or ground. Or attach the black socket to a cold water pipe with as short a piece of wire as possible.

When using external sockets, select EXT. ANT. with the selector switch on the right side of the radio. When using the internal antennas of the radio, switch it to INT. ANT.

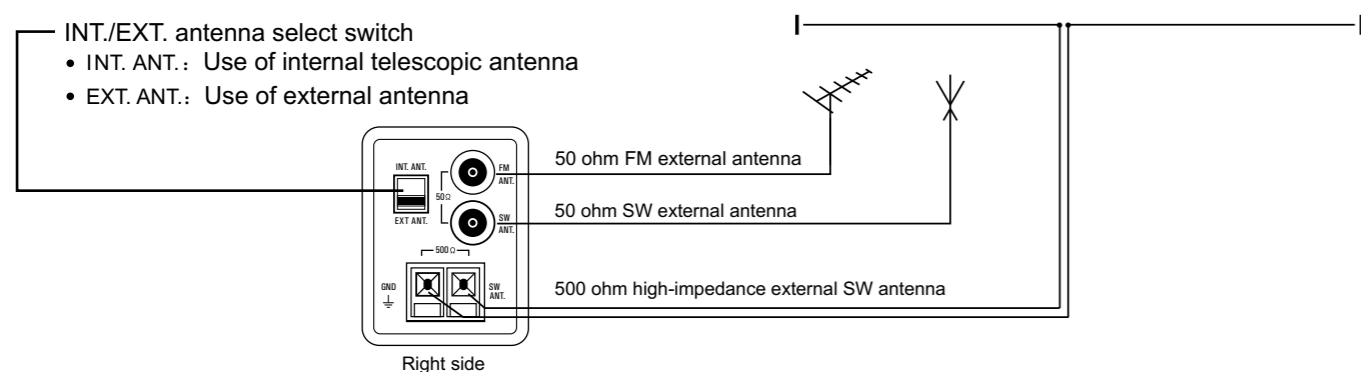

WARNING:

Always unplug all antennas that are mounted outside when a lightning storm is predicted.

To enter different system codes turn off the radio and perform a quick, short press of the ENTER button with a "B" sound. "--" appears on the upper right corner of the display. Enter the system code as below, then push ENTER to confirm the system code while a long "B--" sounds.

CODE	For memory page setting (500 memories)
00 *	10 pages; each page 50 memories
20	20 pages; each page 25 memories
25	25 pages; each page 20 memories
50	50 pages; each page 10 memories
	Step (MW)
09 *	9 kHz
10	10 kHz (North America)
	Type of batteries
29 *	Normal D size batteries (1.5V each battery)
28	Rechargeable batteries (1.2V each battery)
	FM frequency range
76	76-108 MHz (Japan)
87 *	87-108 MHz
88	87.5-108 MHz(North America)

Note: " * " means default setting by the manufacturer.

CHECK THE SYSTEM CODE SETTING

Turn off the radio and long press the ENTER button for about 3 seconds, the system settings show in the display in sequence as "Memory page setting → Step (MW) → FM frequency range → Time setting and the frequency designated of Timer A and Timer B → Type of batteries".

PROBLEM	PROBABLE CAUSE	SOLUTION
Can't turn on the radio or no display or light.	(A) Power connection. (B) Batteries are discharged or not installed for portable operation, no AC power.	(A) Check power supply cables. (B) Check/re-install batteries for portable operation.
The radio auto turns off while listening.	(A) Batteries are discharged. (B) Activate the alarm by radio. (C) Sleep time is over.	(A) Check/re-install batteries. (B) Turn on the radio again. (C) Turn on the radio again.
Noises or nothing stored into memory when ATS.	(A) The signal is too weak. (B) Strong interference nearby.	(A) Manually tuning or direct key in frequency. (B) Use the ANT.ATT or shorten the telescope antenna, then ATS.
No reception when using external antenna.	The antenna selection switch is on INT. ANT.	Switch it to EXT. ANT. position.
Only noises is heard when alarm by radio.	There is no station stored into TIMER A or TIMER B or the station is sleep when alarm by radio.	Store a station into TIMER A or TIMER B.
No stereo when using earphones.	(A) FM signal is too weak. (B) FM ST. is set to MONO. (C) The broadcast is MONO.	(A) Try to change the antenna's direction and its length, or use an external antenna. (B) Set the FM ST. to stereo.
No function.	The MCU is in accident.	Use the RESET button to reboot the unit.

Frequency range LW MW SW AIR FM	100-519kHz 522-1620kHz ----- system code "09" 520-1710 kHz (America) -- system code "10" 1711-29999kHz 118-137MHz 87-108MHz 76-108MHz (Japan) 87.5-108MHz (America)
Sensitivity LW (S/N=26dB) MW (S/N=26dB) SW (S/N=26dB) SSB (S/N=10dB) AIR (S/N=10dB) FM (S/N=30dB)	Less than 3mV/m Less than 0.35mV/m Less than 18 μ V Less than 1 μ V Less than 5 μ V Less than 3 μ V
Selectivity AM	Wideband \pm 10kHz, Greater than 40dB Narrowband \pm 5kHz, Greater than 60dB
FM Stereo crosstalk	Better than 30dB
Signal to Noise Ratio MW SW FM	Greater than 45dB Greater than 50dB Greater than 60dB
IF Frequency	SSB, AM: 1st IF : 55.845MHz 2nd IF: 455kHz FM: 1st IF: 10.7MHz (Single Conversion)
Image Rejection MW/LW/SW AIR FM	55.845MHz: Greater than 90dB 455kHz: Greater than 80dB Greater than 90dB Greater than 60dB
IF Rejection AM FM	55.845MHz: Greater than 60dB 455kHz: Greater than 60dB 10.7MHz: Greater than 100dB

AGC Performance	AGC range: Wider than 80dB Threshold : 12 μ V	
RF GAIN	20dB	
Antenna Attenuation	Three levels: 0dB, -10dB, -20dB	
Internal Antennal	<ul style="list-style-type: none"> ● 1200mm telescoping whip (for use on FM, AIR, SW and SSB bands) ● IFerrite rod antenna ϕ 10X120mm(HQ) (for use from 100kHz through 1800kHz) 	
External Antenna Input	SW	50 Ω (BNC type), 500 Ω
	FM AIR	50 Ω (BNC type)
IF Output	IF: 455kHz Signals output greater than 60mV when input greater than 3 μ V	
Line Audio Outputs	Stereo left and right 300Mv, 4.7k Ω for each output.	
Earphone Jack	ϕ 3.5mm, 8~32 Ω , stereo type	
Internal Speaker	8 Ω / 2W, ϕ 100mm	
Power supply	Batteries : D size, UM1 (alkaline) x 4 AC ~220V/50Hz (AC power cord included for Asia market)	
DC Jack	DC 6V / 350mA, negative polarity \oplus \ominus Outside diameter: ϕ 5.5mm, Core diameter: ϕ 2mm (DC adaptor included for Europe market)	
Current Consumption	Quiescent Current	Standby Current less than 85uA FM less than 70mA MW less than 80mA SW less than 90mA SSB less than 95mA
	Dynamic Current	Rated Current 350mA (Output 650mW, Distortion less than 1%) Maximum Current less than 500mA (Output 1500mW)
Operating Temperature	-5°C to +50°C	
Weight	2.7kg (batteries NOT included)	
Size	372 (W) X 183 (H) X 153 (D) mm (front handle included)	

FUNCTION	BUTTON	OPERATION	TONE	DISPLAY
Light On/Off	LIGHT/SNOOZE	Light temporarily	B	Light for 3 seconds.
		Light always	B--	Light until no power.
		Light off	BB	Turn off the light.
Time setting	TIME	Hour adjusting	B	Hour flashes
		Minute adjusting	BB	Minute flashes
		Confirm or Auto confirm	B--	Nothing flashes
Alarm setting	TIMER A (B)	Alarm hour adjusting	B	Hour flashes
		Alarm minute adjusting	BB	Minute flashes
		Playing time adjusting	BB	Playing time, "✓" and "SLEEP" flash
		Confirm or Auto confirm	B--	
		Activate radio alarm	B	"🔊" appears
		Activate buzzer alarm	BB	"🔔" appears
		Deactivate the alarm	B--	Both "🔊" and "🔔" display
Bandwidth	BW	NARROW	B	"NARROW" appears
		WIDE	BB	"WIDE" appears
SSB Signal Listening*	SSB	USB - Upper Side Band	B	"USB" appears
		LSB - Lower Side Band	BB	"LSB" appears
		AM		Both "USB" and "LSB" display
FM stereo	FM ST.	MONO.	B	"Stereo" is not on
		STEREO	BB	"Stereo" is on when a stereo broadcast is received
Delete Digits	DEL ETE	Every time	B	Delete a digit.
Delete one memory or a memory page	DEL ETE	Start to delete one memory	B	PRESET and "DEL" flash
		Start to delete a memory page	BB	PAGE and "DEL" flash
		Confirm deleting	B--	Deleting finished.
Store a frequency into memory	MEMORY	Storing	B	PRESET flashes in the upper right corner.
		Confirm or auto confirm	BB	PRESET stays.
Quick store	MEMORY	During the auto tuning, every storing.	B	PRESET flashes in the upper right corner.

FUNCTION	BUTTON	OPERATION	TONE	DISPLAY
Confirm or system setting	ETEER	Every operation	B	Start or finish its operation.
		An error occurred	B--	"Err" appears
		Complete the system code setting	B--	
ATS(Auto tuning storage)	FM MW/LW	To start	B	Frequency and PRESET changed
		Stop ATS by pressing any key	BB	Frequency stays
		End of ATS	B--	PO:01 shows in the upper right corner and its frequency displays
FM band selection	FM	FM	B	"FM" appears and a FM frequency displays
MW/LW band selection	MW/LW	MW	B	"MW" appears and a MW frequency displays
		LW	BB	"LW" appears and a LW frequency displays
SW band selection	SW	SW	B	"SW" appears and a MW frequency displays
		Select a SW meter band	B	A meter band flashes in the upper right corner
Go in/out the range of a meter band	SW, TUNING knob, UP/DOWN	Go in	B	A meter band flashes in the upper right corner
		Go out	B	Time displays in the upper right corner
AIR band selection	AIR	AIR	B	AIR appears and a AIR frequency displays
Tuning step and lock	STEP/LOCK	Slow tuning	B	">" is on
		Fast tuning	BB	">>" is on
		Lock the tuning knob	B--	"🔒" appears
		Unlock	B	"🔒" disappears
Auto scanning	UP/DOWN	Start scanning	B	">" flashes and frequency changed
		Stop scanning by pressing any key	BB	">>" and the frequency stay
Auto-scan memory	UP/DOWN	Start auto-scan	B	"PRESET" flashes and the memory number changes
		Stop scanning by pressing any key	BB	"PRESET" and the memory number stay

FUNCTION	BUTTON	OPERATION	TONE	DISPLAY
Mode alternation frequency and memory	VM/VF	VF: frequency tuning mode	B	Time shows in the upper right corner
		VM: memory mode		PAGE and PRESET show in the upper right corner
Page selection	PAGE	Start to select	B	PAGE flashes
		Confirm/Auto confirm	B	PAGE stays
Sleep timer setting	SL EEP	Choose 30 minutes	B	30 is on
		Choose 90 minutes	BB	90 is on
		Auto confirm	B--	Frequency shows
Antenna attenuator	ANT.ATT.	Maximum level	B - -	Att. indicates: 0 dB
		Intermediate level	BB	Att. indicates: -10dB
		Lowest level	B	Att. indicates: -20dB

Note: it will be the same "B" sound when you press the SSB button to select USB, LSB or AM band at the beginning and the ending of a meter band, ie, either 11500 kHz or 12150 kHz of 25 meter band.